

PAPER END

OPTION

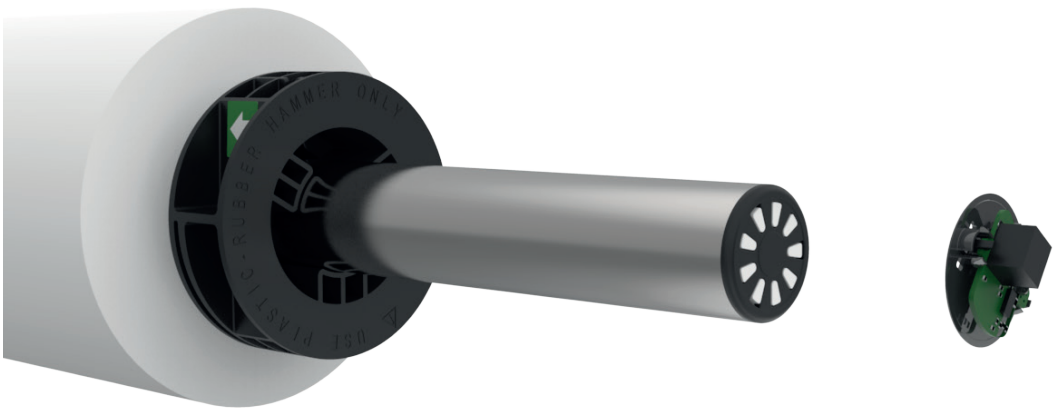

**INSTALLATION & OPERATION
GUIDE**



INDEX

Description	5
Box contents	6
Previous requirements	7
Option card	8
Option installation	10
Verifying Option installation on Plotter	11
Verifying Option installation on Software	12
Maintenance: Clean	13
Technical Service	14
Notes	15



DESCRIPTION

Paper End detects when the roll paper is over and stops printing in order to avoid paper jam.

BOX CONTENT

Check the boxes to verify that all parts are present.

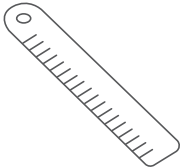

x1
Ruler

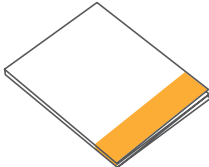

x1 - Installation & Operation guide



x1 - Activation
card



PREVIOUS REQUIREMENTS

- Verify that the plotter firmware version is higher than 6.0.0.0.

To find out your plotter's firmware version, go to:

Menu > Options > Info > Firmware versions

OPTION CARD



TDOT

POWERFULLY REIMAGINED



OPTION INSTALLATION

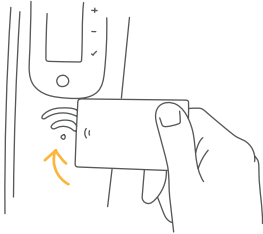

01. Get the option card and pass it through the RFID zone (on the right side panel) for at least 2 seconds, until you hear the acoustic signal.

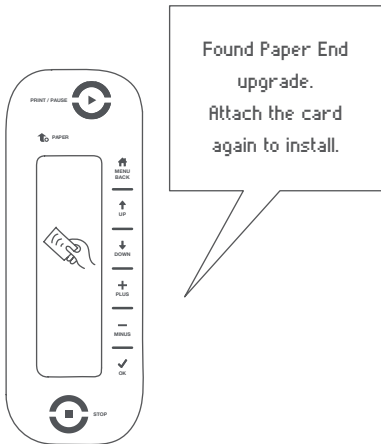

02. Check the verification message installation in the display.

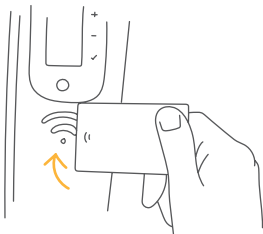

03. Pass again the card to validate the installation, until you hear the acoustic signal.

VERIFYING OPTION INSTALLATION ON PLOTTER

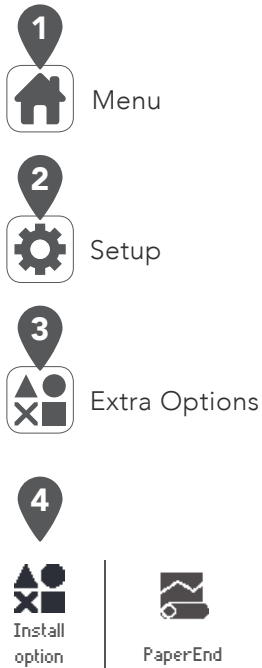

On the operator panel keyboard press the Menu button. (1)

Select the Setup menu (2) and press Ok.

Select the Extra Options menu (3) and press Ok.

Check the installation of the **Paper End** option. (4)

Press the Menu button to get back.

VERIFYING OPTION INSTALLATION ON SOFTWARE

In the main User Manager screen select the "Customer Programs" (1) and select "Plug-ins and Options" (2). Check that the **Paper End** option is correctly installed (3). Press Accept to exit. (4).

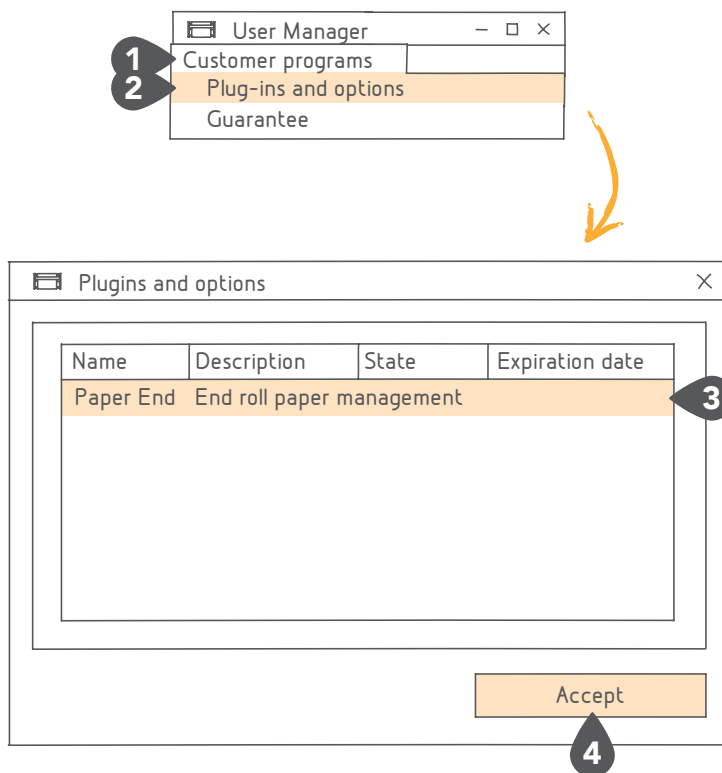

* To verify the installation using the lan connection the server must be configured previously.

MAINTENANCE: CLEAN

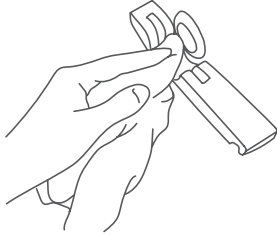

- 01.** Clean paper bar support and paper-end sensor using a microfiber cloth.

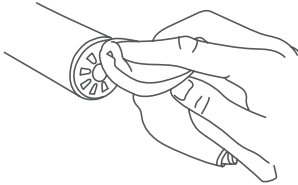

- 02.** Clean paper bar cap.

TECHNICAL SERVICE

Please contact your dealer for technical support in case of any issue.

204974_190701